

# OTUSSO

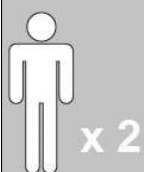
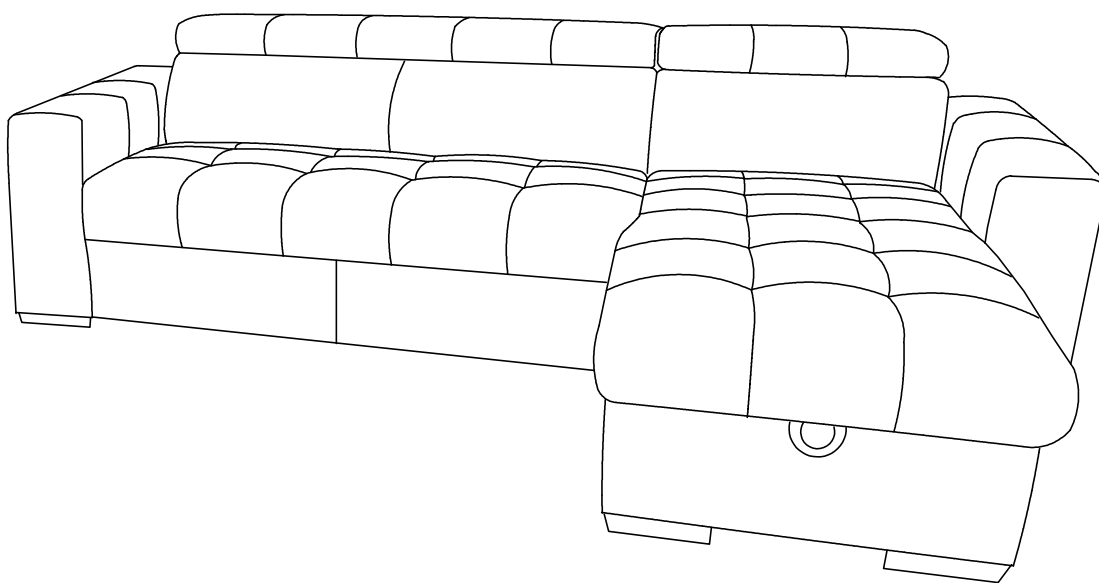

PL

INSTRUKCJA MONTAŻU  
INSTRUKCJA OBSŁUGI

GB

ASSEMBLY INSTRUCTIONS  
INSTRUCTION MANUAL

D

MONTAGEANLEITUNG  
BEDIENUNGSANLEITUNG

NL

HANDLEIDING VOOR DE MONTAGE  
GEBRUIKSAANWIJZING

TR

MONTAJ TALIMATI  
KULLANIM KLAVUZU

RU

ИНСТРУКЦИЯ ПО МОНТАЖУ  
ИНСТРУКЦИЯ ПО ЭКСПЛУАТАЦИИ

RO

INSTRUCȚIUNI DE INSTALARE  
INSTRUCȚIUNI DE UTILIZARE

IT

ISTRUZIONI DI MONTAGGIO  
MANUALE DI ISTRUZIONI

FR

NOTICE DE MONTAGE  
MANUEL INSTRUCTIONS

SK

MONTÁŽNY NÁVOD  
NÁVOD NA POUŽITIE

HU

SZERELÉSI ÚTMUTATÁS  
KEZELÉSI UTASÍTÁS

CZ

MONTÁŽNÍ NÁVOD  
NÁVOD K POUŽITÍ

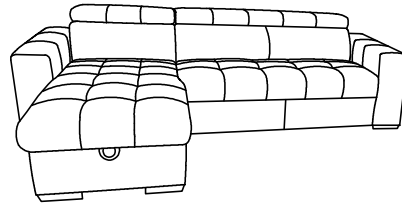
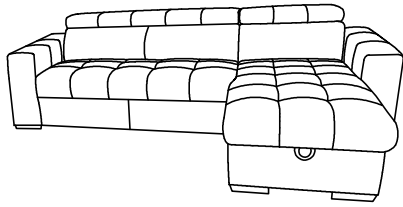

1

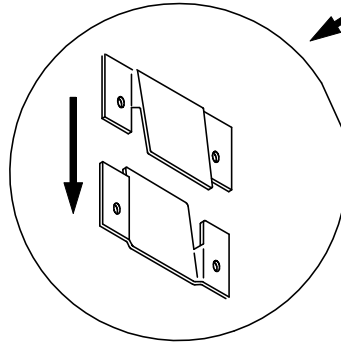
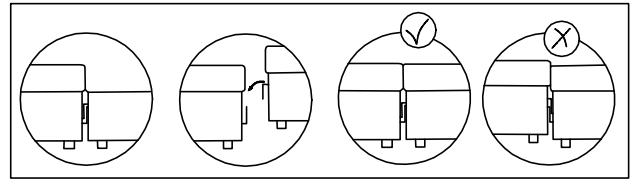
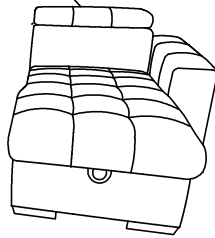
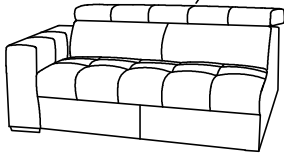
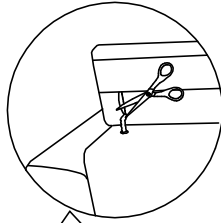

2

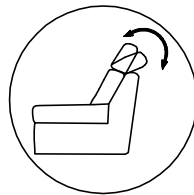
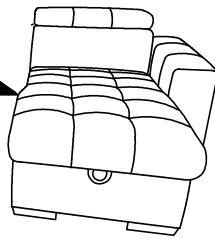
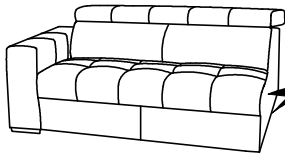

3

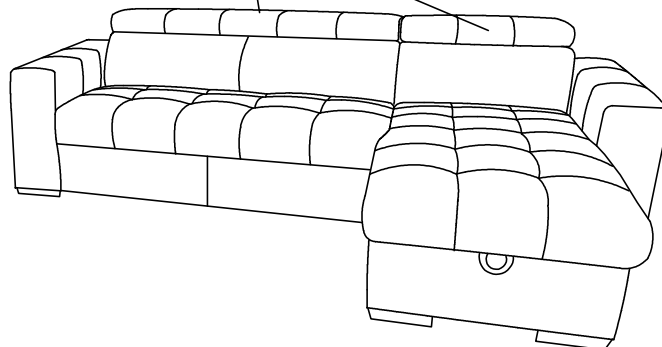

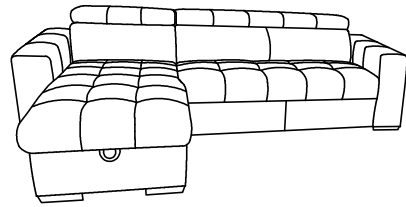
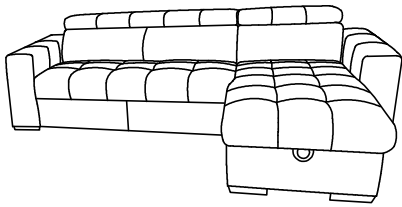

4

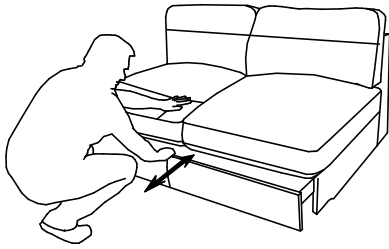

5

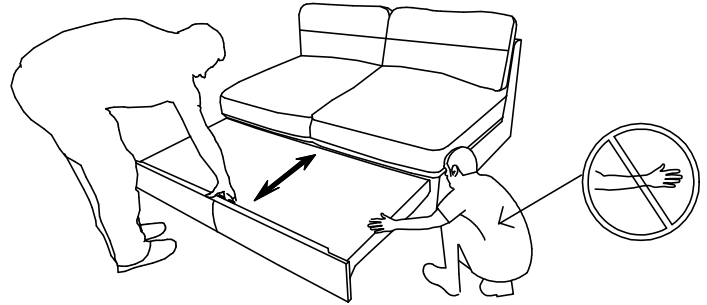

6

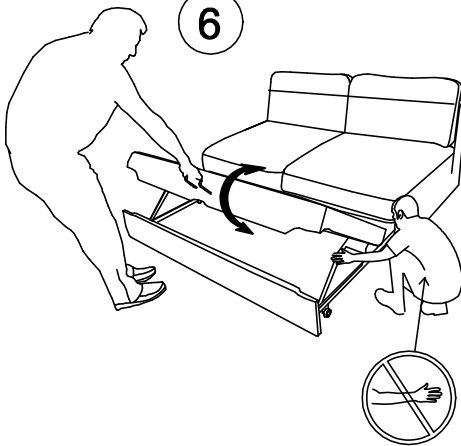

7

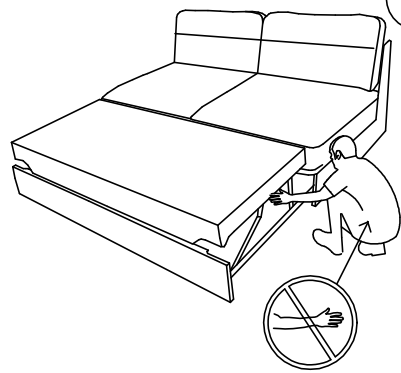

8

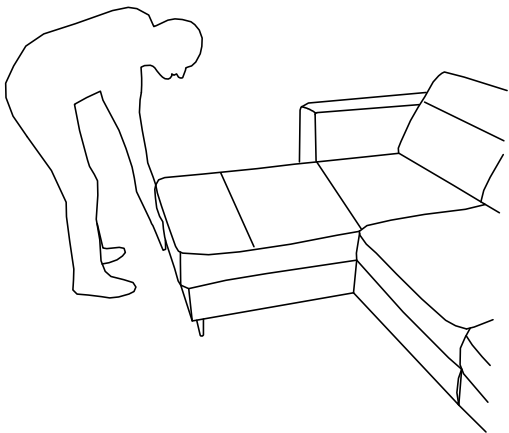

9

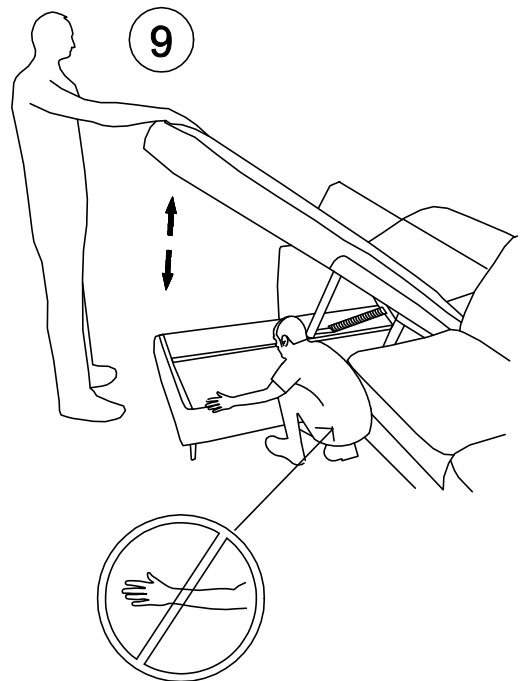

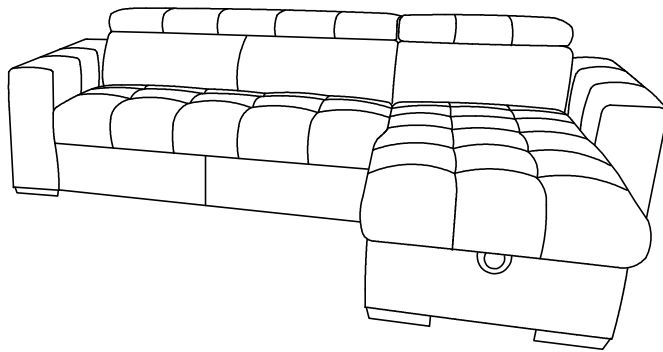
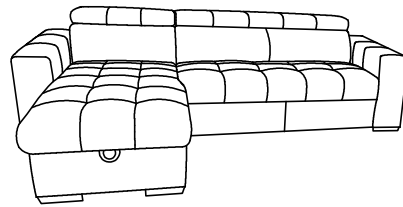
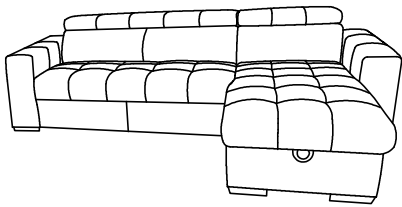



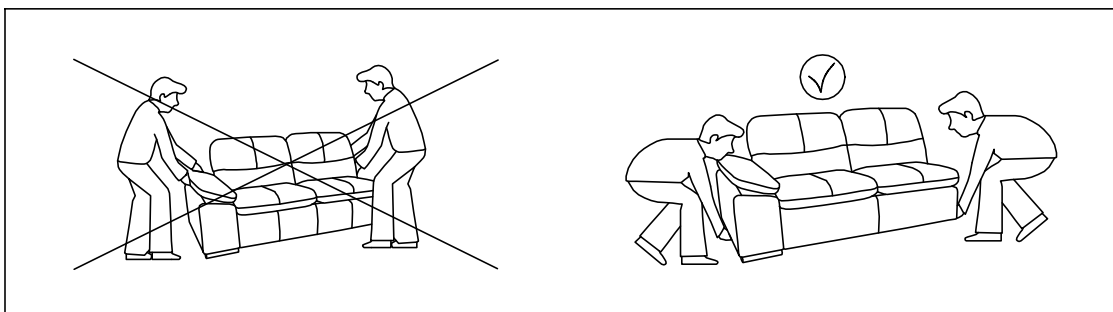
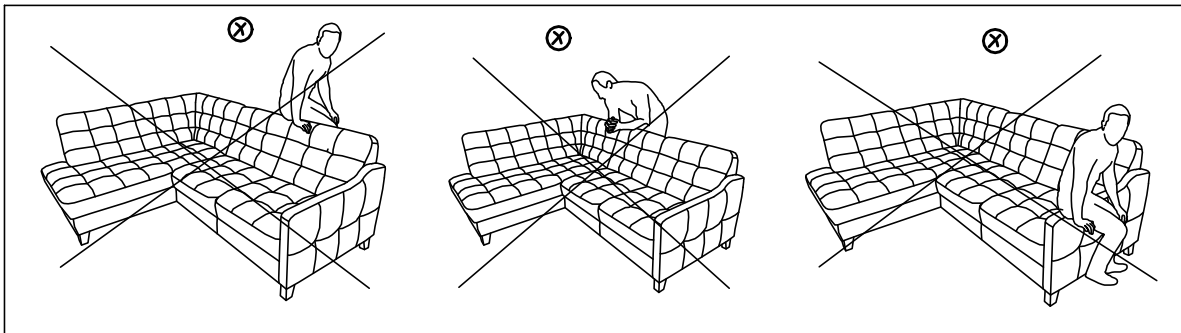
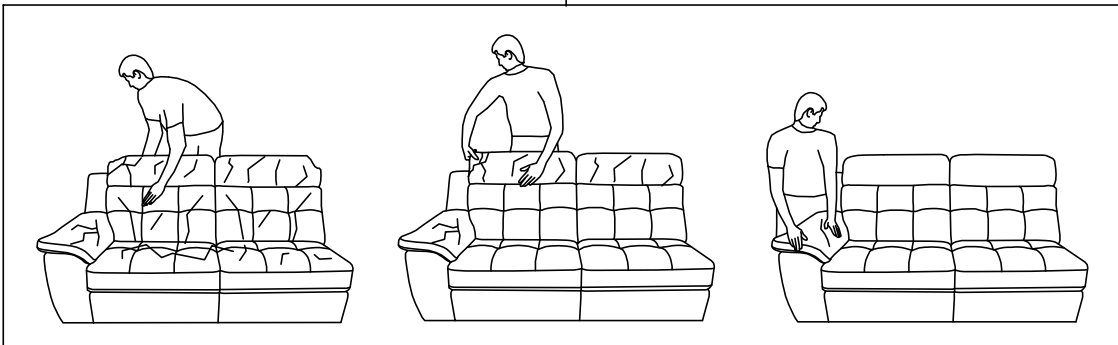
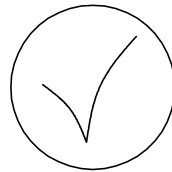

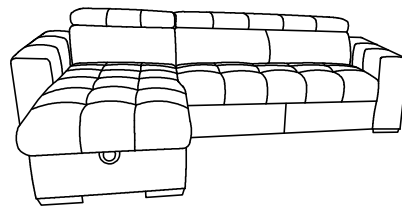
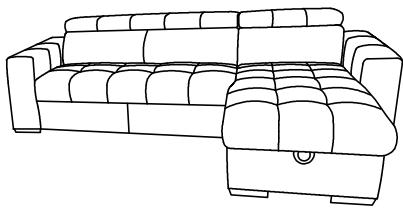





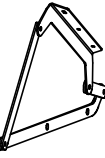
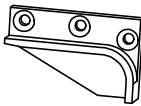
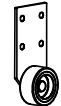

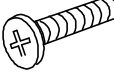

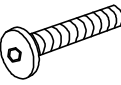

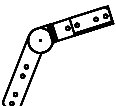
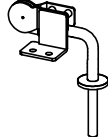
10

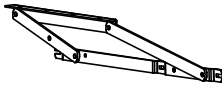

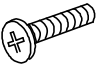
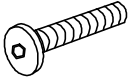

Service – Assistenza – Dienstverlening – Serwis – Servis – Szerviz – Сервисная служба

<p>(A)</p>  <p>.....</p>	<p>(B)</p>  <p>.....</p>	<p>(C)</p>  <p>.....</p>
<p>(D)</p>  <p>.....</p>	<p>(E)</p>  <p>.....</p>	<p>(F)</p>  <p>.....</p>
<p>(G)</p>  <p>ø5 x 30</p> <p>.....</p>	<p>(H)</p>  <p>M6 x 25</p> <p>.....</p>	<p>(I)</p>  <p>M6 x 25</p> <p>.....</p>
<p>(J)</p>  <p>M6 x 20</p> <p>.....</p>	<p>(K)</p>  <p>ø8 x 24 x 2</p> <p>.....</p>	<p>(L)</p>  <p>.....</p>
<p>(M)</p>  <p>.....</p>	<p>(N)</p>  <p>.....</p>	<p>(O)</p>  <p>ø 50x50</p> <p>.....</p>
<p>(P)</p>  <p>.....</p>	<p>(R)</p>  <p>.....</p>	<p>(S)</p>  <p>M6 x 40</p> <p>.....</p>
<p>(T)</p>  <p>.....</p>	<p>(U)</p>  <p>M8</p> <p>.....</p>	<p>(V)</p>  <p>filc 60/40</p> <p>.....</p>
<p>(W)</p>  <p>ø 40</p> <p>.....</p>	<p>(X)</p>  <p>M8x130</p> <p>.....</p>	<p>(Y)</p>  <p>M6 x 20</p> <p>.....</p>
<p>(Z)</p>  <p>M8 x 80</p> <p>.....</p>		